

# Trapezoidal IntuiSwitch™ Mounting Templates

<http://www.intuiswitch.com> email [info@intuiswitch.com](mailto:info@intuiswitch.com) 913-489-9033

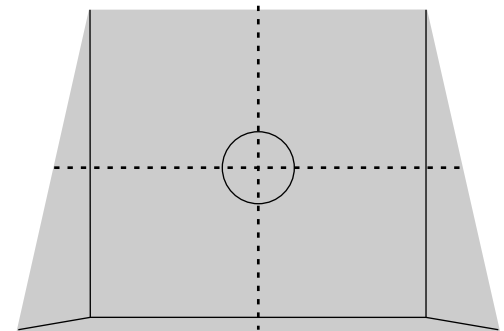
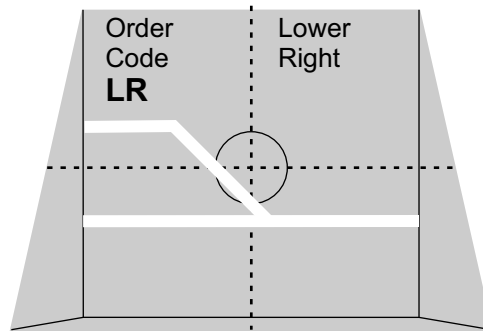
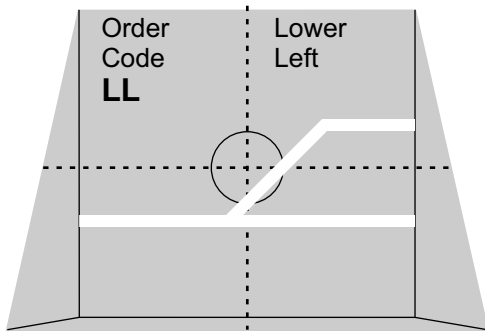
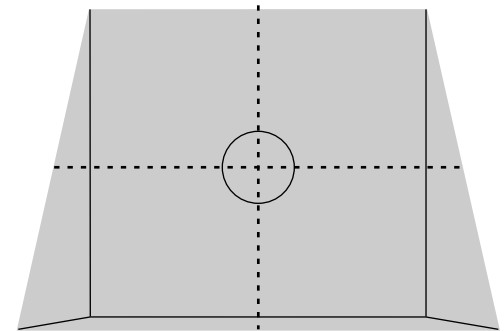
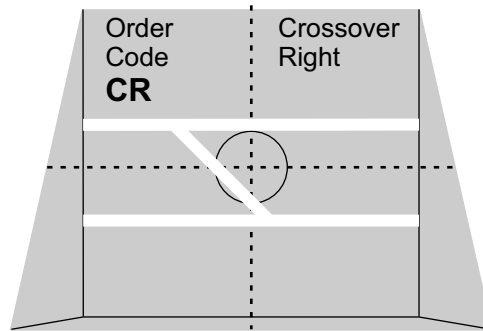
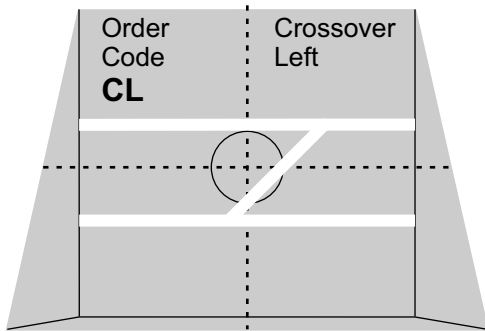
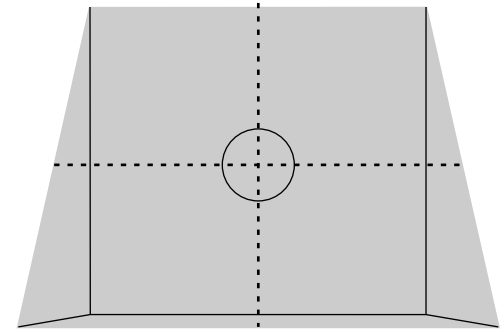
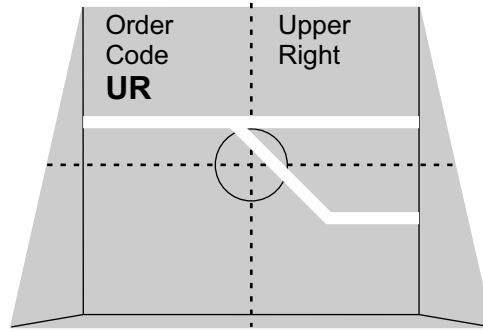
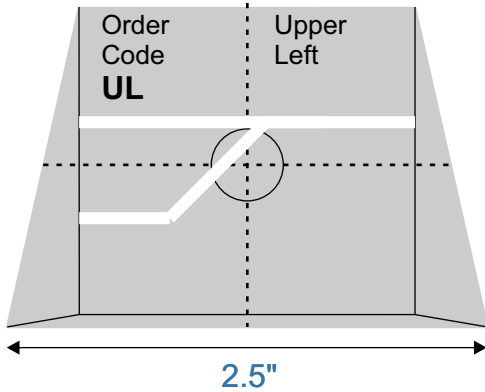

When printing these templates, be sure to use the Actual Size print setting for most accurate rendition.

Suggested cable hole diameter is 3/8" (9mm). Hole need not be precisely centered, but keeping it close to the center will make cable routing easier.

IS\_TPL002 V1.01  
Trapezoidal IntuiSwitch Templates  
© 2024 ESELCO